

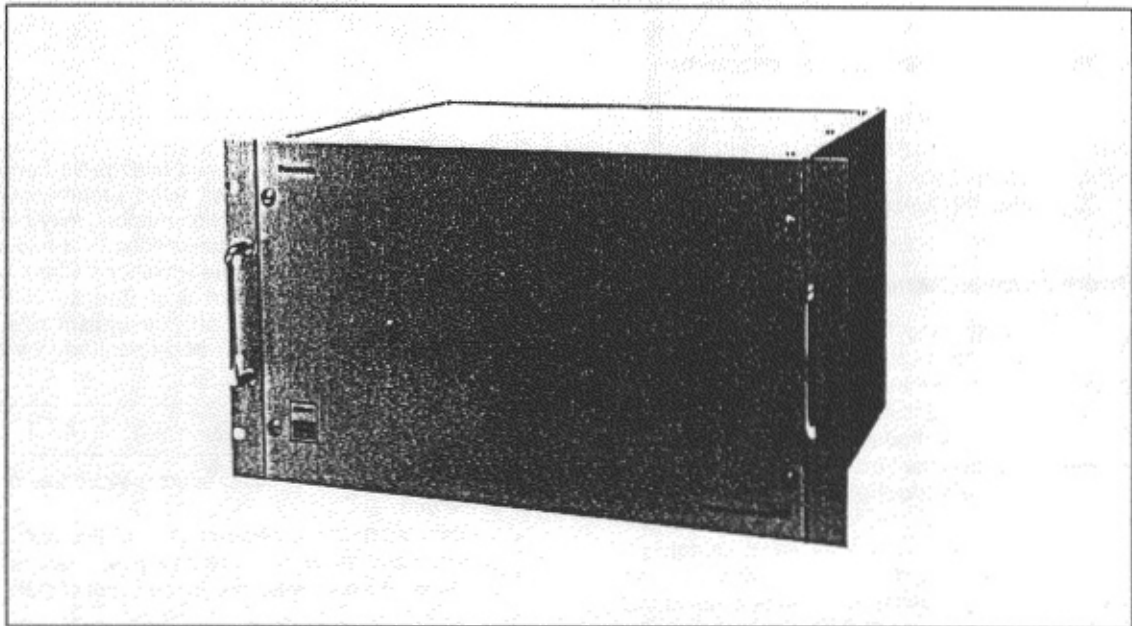

# Operating Instructions

Extension Unit  
WJ-AD550



**Panasonic®**

Before attempting to connect or operate this product, please read these instructions completely

	<b>CAUTION</b> RISK OF ELECTRIC SHOCK DO NOT OPEN	
<p><b>CAUTION:</b> TO REDUCE THE RISK OF ELECTRIC SHOCK, DO NOT REMOVE COVER (OR BACK). NO USER SERVICEABLE PARTS INSIDE. REFER SERVICING TO QUALIFIED SERVICE PERSONNEL.</p>		

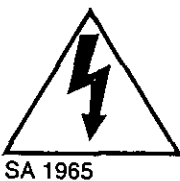

The lightning flash with arrowhead symbol, within an equilateral triangle, is intended to alert the user to the presence of uninsulated "dangerous voltage" within the product's enclosure that may be of sufficient magnitude to constitute a risk of electric shock to persons.



The exclamation point within an equilateral triangle is intended to alert the user to the presence of important operating and maintenance (servicing) instructions in the literature accompanying the appliance.

-For U.S.A-

**Warning:**  
This equipment generates and uses radio frequency energy and if not installed and used properly, i.e., in strict accordance with the instruction manual, may cause harmful interference to radio communications. It has been tested and found to comply with the limits for a Class A computing device pursuant to Subpart J of Part 15 of FCC Rules, which are designed to provide reasonable protection against such interference when operated in a commercial environment.

The serial number of this product may be found on the rear of the unit.  
You should note the serial number of this unit in the space provided and retain this book as a permanent record of your purchase to aid identification in the event of theft.

Model No. \_\_\_\_\_

Serial No. \_\_\_\_\_

**WARNING:**  
TO PREVENT FIRE OR SHOCK HAZARD, DO NOT EXPOSE THIS APPLIANCE TO RAIN OR MOISTURE.

## PREFACE

The WJ-AD550 Extension Unit, when combined with the optional WJ-SX550A Matrix Switcher and WV-CU550A System Controller, allows for flexible control of 128 cameras and 16 monitors.

## FEATURES

The WJ-AD550 Extension Unit is used to expand the Camera Input for 65 up to 128 in the Matrix Switcher System. Up to 14 optional boards are installed in this unit to meet the system requirement.

The optional boards are shown below.

- WV-PB5508 Video Input Board: Up to 8 boards
- WV-PB5504A Video Output Board: Up to 4 boards
- WV-PB5564 Alarm Board: Up to 2 boards
- WV-PB5548 Data Board: Up to 8 boards

## PRECAUTIONS

- All necessary procedures, with regards to the installation of this unit should be made by qualified service personnel or system installers.
- Do not attempt to disassemble the unit.  
In order to prevent electric shock, do not remove screws or covers. There are no user-serviceable parts inside.
- Handle the unit with care.  
Do not abuse the unit. Avoid striking, shaking, etc. It could be damaged by improper handling or storage.
- Do not expose the unit to rain or moisture, or try to operate it in wet areas.  
Do take immediate action if ever the unit becomes wet. Turn the power off and refer servicing to qualified service personal. Moisture can damage the unit and also create the danger of electric shock.
- Do not use strong or abrasive detergents when cleaning the unit body.  
Do use a dry cloth to clean the unit when dirty.  
In case the dirt is hard to remove, use a mild detergent and wipe gently.
- Do not operate the unit beyond its temperature, humidity or power source ratings.  
Do not use the unit in an extreme environment where high temperature or high humidity exist.  
Use the unit under conditions where temperatures are within  $-10^{\circ}\text{C}$  -  $+50^{\circ}\text{C}$  ( $14^{\circ}\text{F}$  -  $122^{\circ}\text{F}$ ), and humidity is below 90%.  
The input power source is 120V AC 60 Hz.

# MAJOR OPERATING CONTROLS AND THEIR FUNCTIONS

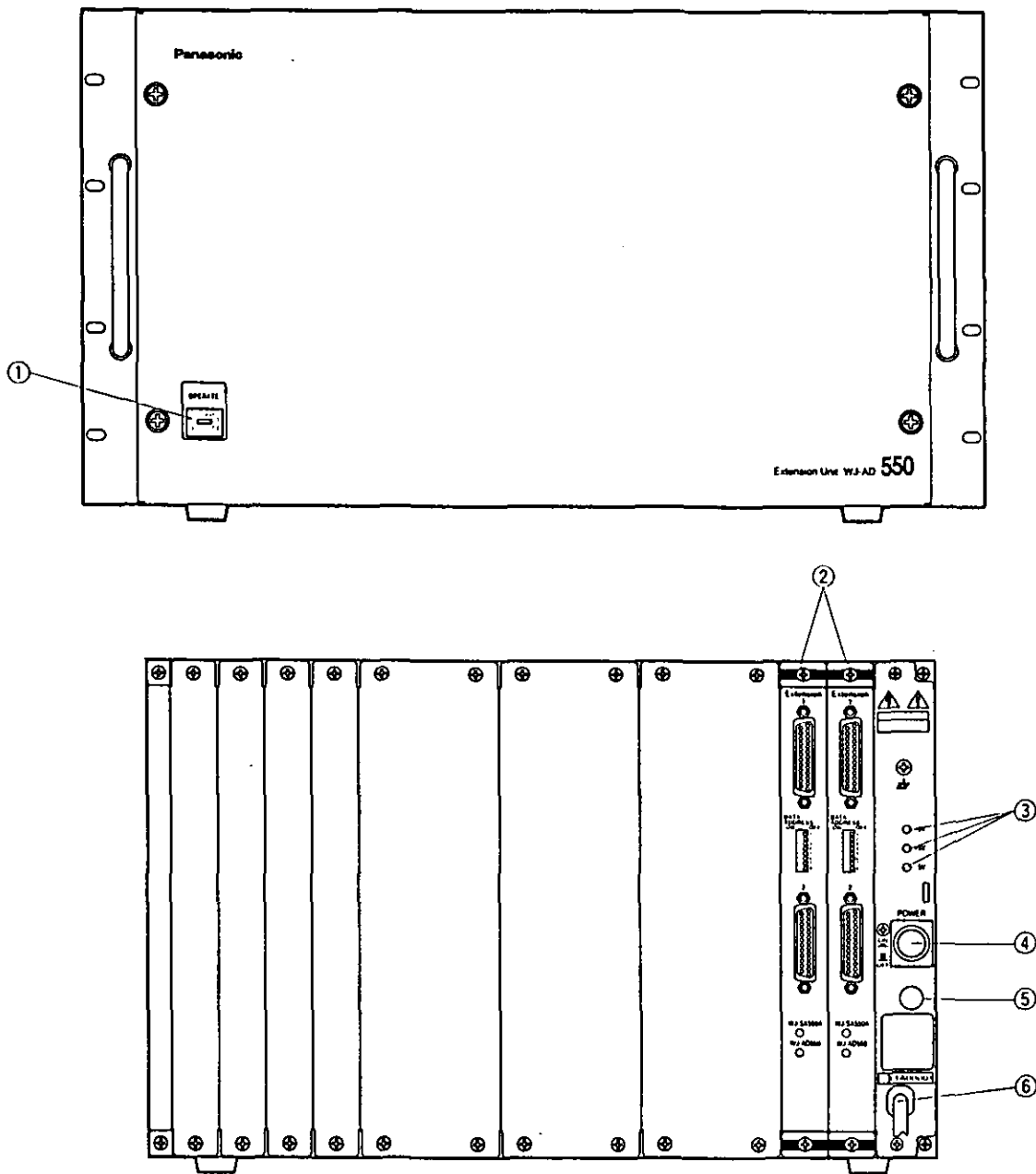

## 1. Operation Indicator (OPERATE)

This indicator lights up when the WJ-AD550 Extension Unit is turned power on.

## 2. Extension Board (EXTENSION)

One of these boards is used to install in the WJ-SX550A Matrix Switcher. Connect these boards by supplied 25-pin Connection Cables to expand the Matrix Switcher System.

## 3. Voltage Indicator (+9V, +5V, -5V)

These LEDs indicate the presence of +9V, +5V and -5V regulated DC voltages.

## 4. Power On/Off Switch (POWER ON/OFF)

This switch is used to turn the Extension Unit power on or off.

## 5. Fuse Holder

## 6. Power Cord

## Extension Board

### 1. Extension Connector ( 1, 2 )

These connectors are used to expand the Matrix Switcher System. Connect each connector between the boards that are installed in the WJ-SX550A Matrix Switcher and WJ-AD550 Extension Unit.

### 2. Data Unit Address Switch (DATA ADDRESS ON/OFF)

These switches are used to identify the unit address number of the Data Board installed in the WJ-AD550 Extension Unit. Select the switches on the board that is installed in the WJ-SX550A Matrix Switcher, to the "ON" position to meet the Data Board Number.

### 3. WJ-SX550A Indicator (WJ-SX550A)

This indicator lights up if the board is installed in the WJ-SX550A Matrix Switcher after making dip switch setting.

### 4. WJ-AD550 Indicator (WJ-AD550)

This indicator lights up if the board is installed in the WJ-AD550 Extension Unit after making dip switch setting.

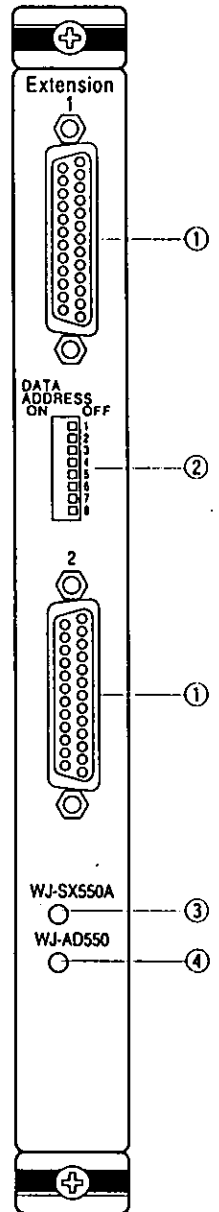

# INSTALLATIONS

The installations described below should be made by qualified service personnel or system installer.

**Caution:** Before starting procedures below, be sure to turn off the Power Switch of the WJ-SX550A Matrix Switcher and WJ-AD550 Extension Unit.

## Remove the Extension Boards

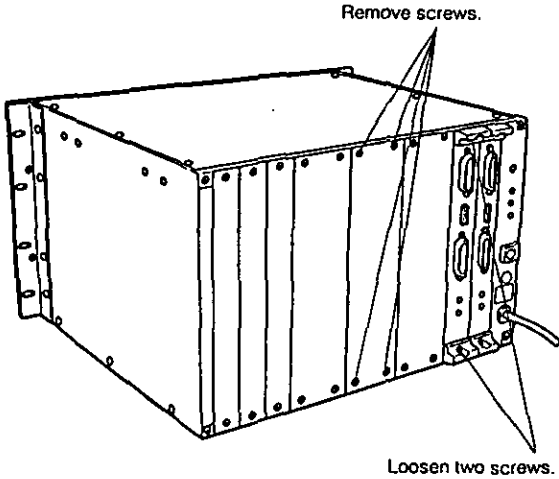

1. Remove the screws from rear panel(s) of the Extension Unit.
2. Remove the rear panel(s).
3. Loosen the two screws on the Extension Board(s).
4. Pull out the Extension Board(s) from the rear of Extension Unit by sliding it inside the board guides.

## Extension Board Dip Switch Setting

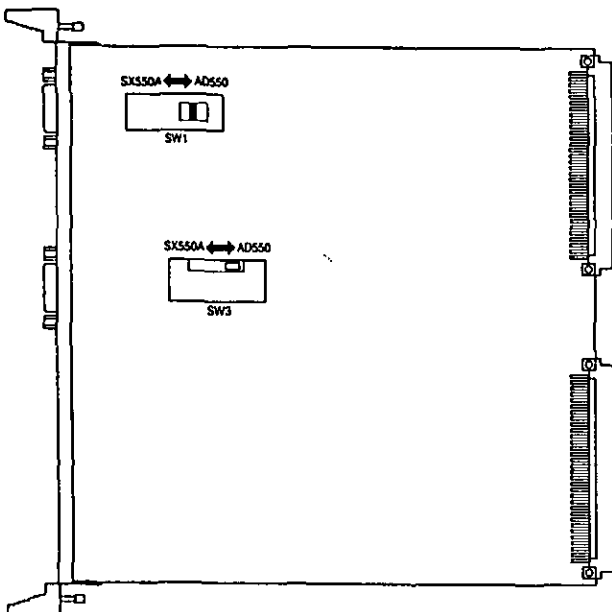

1. Set switches (SW1/SW3) on the board to choose the system requirement as shown below.  
**SX550A:** Select this position if the board is installed in the WJ-SX550A Matrix Switcher.

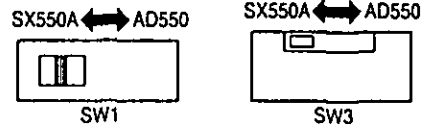

- AD550:** Select this position if the board is installed in the WJ-AD550 Extension Unit.

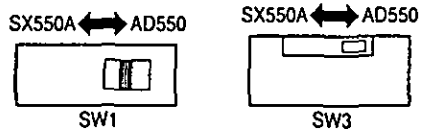

Initially, AD550 positions are selected at the factory.

2. Set the Data Unit Address Switch on the board to meet the Data Boards as shown below.
  - 1) The board installed in the WJ-SX550A  
Set the switches to the "ON" positions to meet the identification number of the Data Boards where installed in the WJ-AD550 Extension Unit.
  - 2) The board installed in the WJ-AD550  
Always keep these switches in the "OFF" positions in the field.

## WJ-SX550A Matrix Switcher

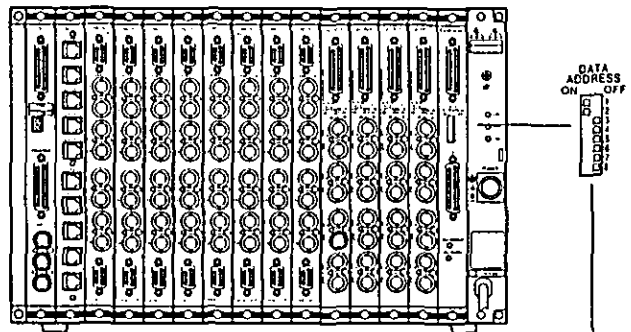

## WJ-AD550 Extension Unit

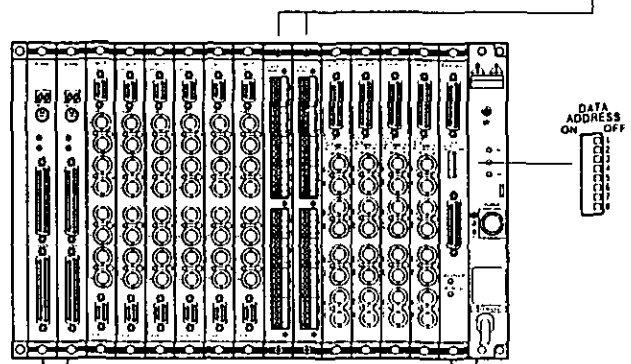

Initially, "OFF" positions are selected at the factory.

## Installing Additional Boards for Expansion

1. Place the board into the desired position in the rear of the Extension Unit (or Matrix Switcher) by sliding it inside the board guides.

**Note:** Each slot is identical, so the board can be installed in any slot.

However it is recommended to install the boards as shown below for an orderly installation.

### WJ-SX550A Matrix Switcher

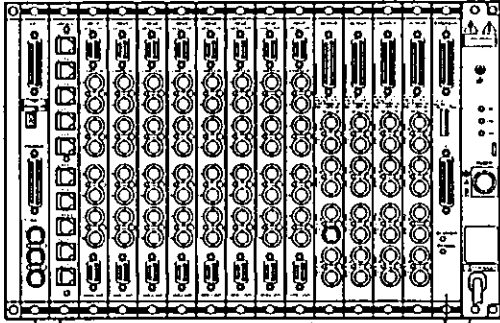

Video Input Board (Board #1-8)      Video Output Board (Board #1-4)      Extension Board

### WJ-AD550 Extension Unit

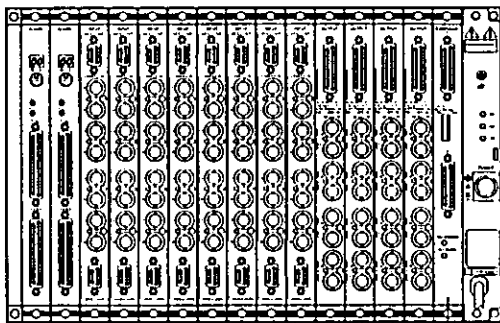

Alarm Board      Video Input Board (Board #9-16)      Video Output Board (Board #5-8)      Extension Board

2. Make sure to push in the board until it is seated firmly.
3. Secure the board by tightening the two screws on the board.
4. Close off open spaces on the rear of the Extension Unit (or Matrix Switcher) by using WV-Q63 Blank Panels (Optional) or supplied rear panel(s).

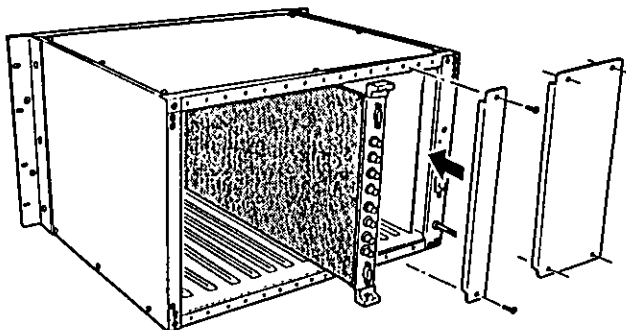

## Mounting into the Rack

1. Remove four rubber feet by removing four screws on the bottom of the Extension Unit (or Matrix Switcher).

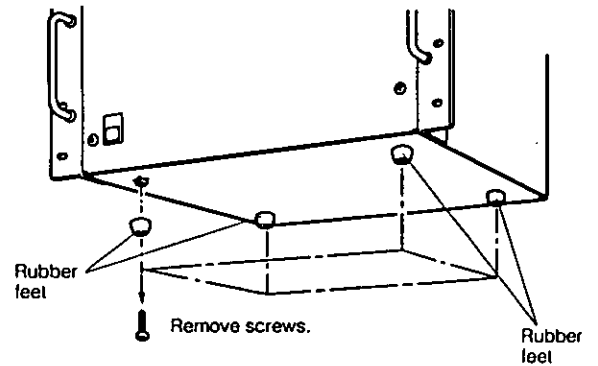

2. Install the Extension Unit (or Matrix Switcher) in the rack by using eight screws procured locally.

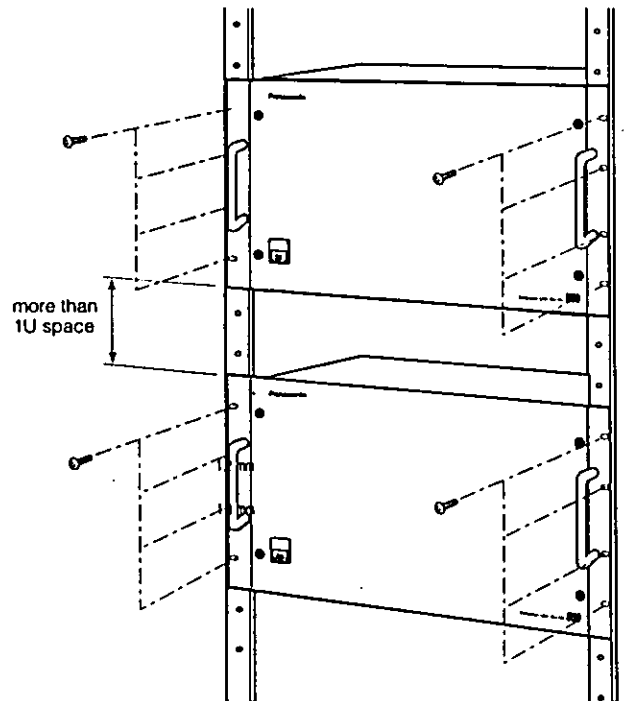

**Note:** The cooling fans inside the Extension Unit (or Matrix Switcher) are article of consumption, and need to replace periodically.

### Cautions:

- Do not block the ventilation opening or slots on the cover to prevent the unit from rising temperature. Always keep the temperature in the rack within 50°C (122°F).
- Secure the rear of the unit to the rack by using the additional mounting angles procured locally when the vibration is added to the rack.

# Connections between the Matrix Switcher

Caution: Before connecting these boards, be sure to set the dip switches correctly.

1. Connect the Extension Boards by supplied 25-pin Connection cable as shown below.

WJ-SX550A Matrix Switcher

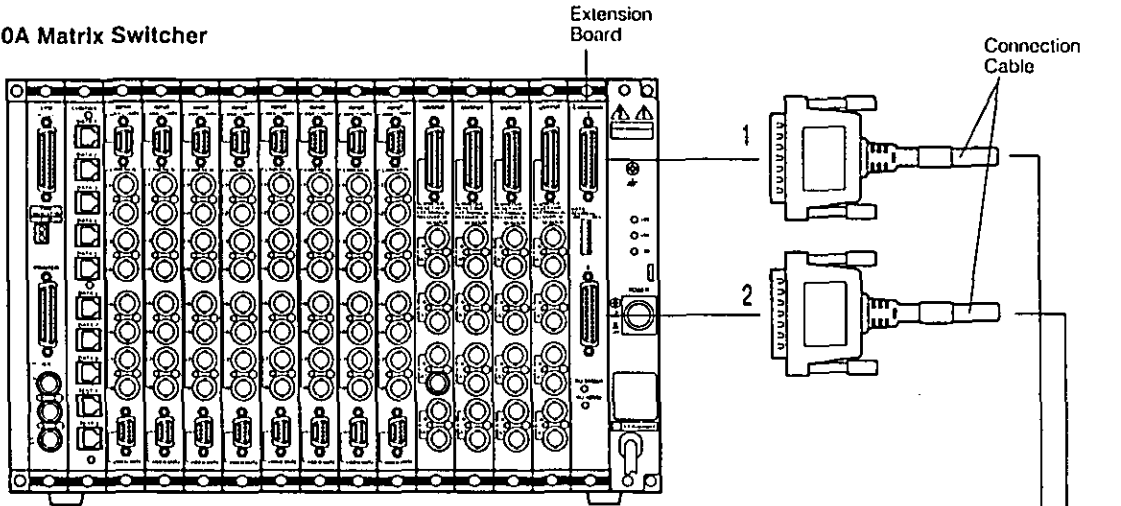

WJ-AD550 Extension Unit

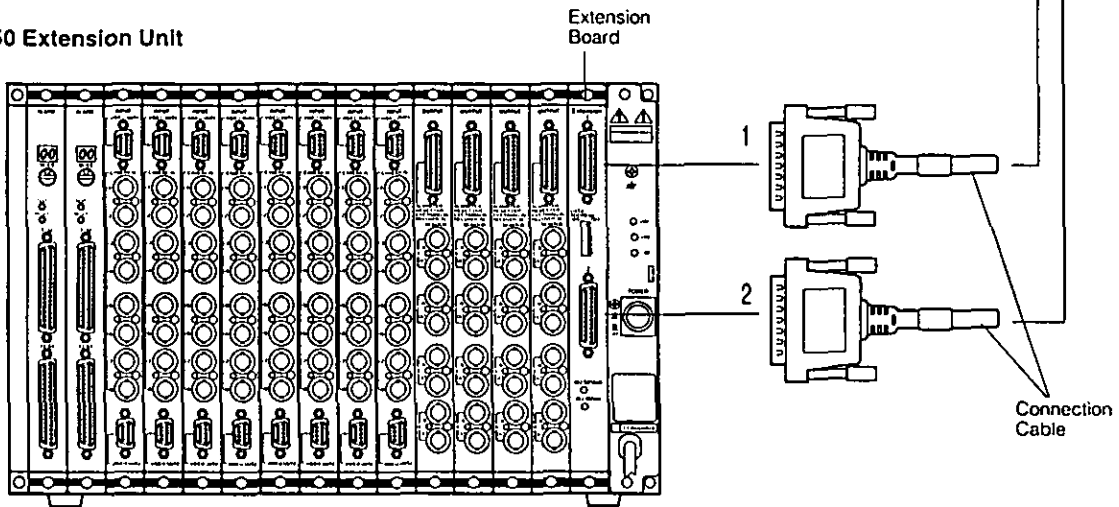



2. Connect the Video Output Boards by coaxial cables as shown below.

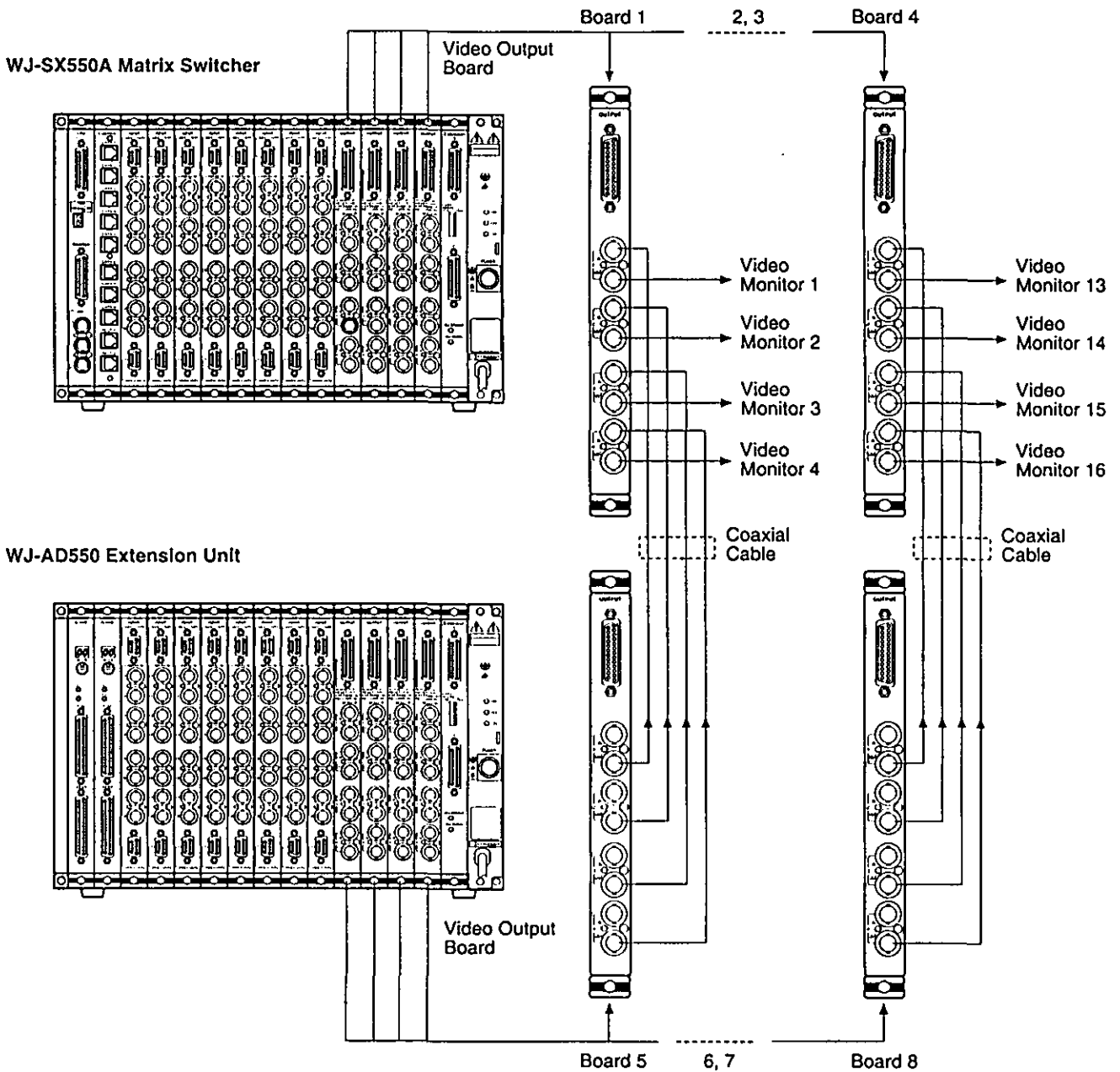

**Note:** The same quantities of Video Output Boards, that are installed in the Matrix Switcher, should be installed in the Extension Unit.

**Note**

Refer to the Operating Instructions of WJ-SX550A for further details.

## SPECIFICATIONS

### General

Power Supply:	120V AC 60Hz
Power Consumption:	Max. 75W with all optional boards installed
Max. Number of Video Input Board:	8 (total 64 Input); Unit Address 9-16
Max. Number of Video Output Board:	4 (total 16 Output); Unit Address 5-8
Max. Number of Alarm Board:	2 (total 128 Alarm Input); Unit Address 1-2
Max. Number of Data Board:	8 (total 64 Data Input); Unit Address 1-8
Ambient Operating Temperature:	-10°C - +50°C (14°F - 122°F)
Ambient Operating Humidity:	Less than 90%
Dimensions:	480 (W) x 265 (H) x 371 (D) mm 18-7/8" (W) x 10-7/16" (H) x 14-5/8" (D)
Weight:	12.5 kg (27.5 lbs.)

Weight and dimensions shown are approximate.  
Specifications are subject to change without notice.

## STANDARD ACCESSORY

25-pin Connection Cable 1m (3.3 ft.) ..... 2 pcs.

## MAJOR OPTIONAL UNITS AND ACCESSORIES

Matrix Switcher	WJ-SX550A
System Controller	WV-CU550A
Video Input Board	WV-PB5508
Video Output Board	WV-PB5504A
Alarm Board	WV-PB5564
Data Board	WV-PB5548
Rack Angle Bracket	WV-Q62
Blank Panel	WV-Q63



# Panasonic

Broadcast & Television Systems Company

Division of Matsushita Electric Corporation of America

## IMAGING SYSTEMS DIVISION

Executive Office: One Panasonic Way 3E-7, Secaucus, New Jersey 07094

### Regional Offices:

Northeast: 43 Hartz Way, Secaucus, NJ 07094 (201) 348-7303

Southeast: 1225 Northbrook Parkway, Suite 1-160, Suwanee, GA 30174 (770) 338-6835

Midwest: 1707 North Randall Road, Elgin, IL 60123 (708) 468-5200

Southwest: 4500 Amon Carter Blvd., Fort Worth, TX 76155 (817) 685-1117

Western: 6550 Katella Ave. 17A-5, Cypress, CA 90630 (714) 373-7265

### MATSUSHITA ELECTRIC OF CANADA LIMITED

5770 Ambler Drive, Mississauga, Ontario, L4W 2T3 Canada (905)624-5010

### PANASONIC SALES COMPANY

DIVISION OF MATSUSHITA ELECTRIC OF PUERTO RICO, INC.

San Gabriel Industrial Park, 65th Infantry Ave. KM. 9.5 Carolina, Puerto Rico 00630 (809)750-4300